

KARTSANA

Life-moving innovation



BRAVA SERIES



BRAVA SERIES



Control, comfort and safety

Top-of-the-range high-autonomy electric stretchers equipped with a number of features for handling with ease.



01

300 kg unassisted

Stretcher with a hydraulic elevation system which can lift loads of up to 300 kg unassisted.



02

Telescopic frame

The headrest area features a telescopic frame to facilitate manoeuvring in places with difficult access.



03

Unlocking pedal

Wheels are unlocked using a single pedal to give the operator maximum control.



04

Control panel

New and improved control panel, now more intuitive, autonomous and functional.



05

Emergency lights

For increased safety.



06

Maximum autonomy

Features 2 batteries for guaranteed autonomy.



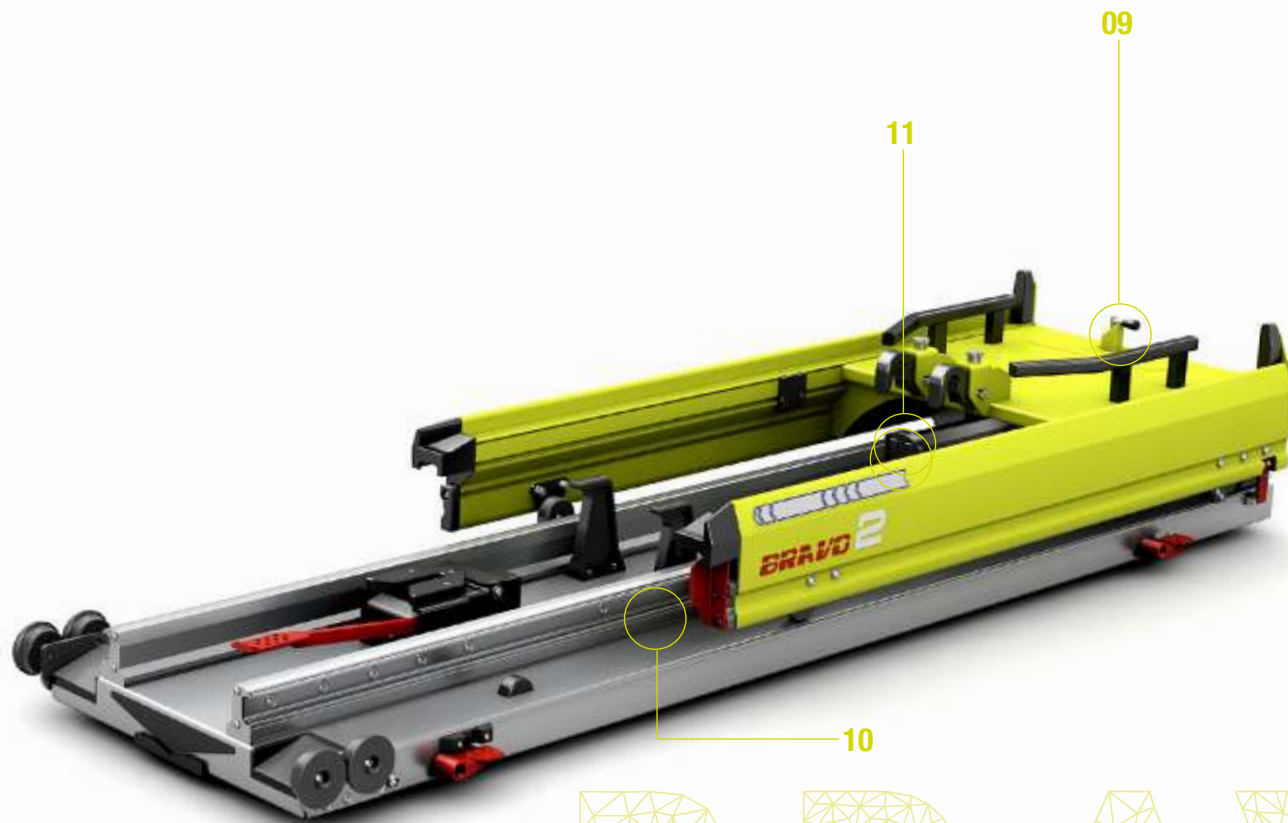
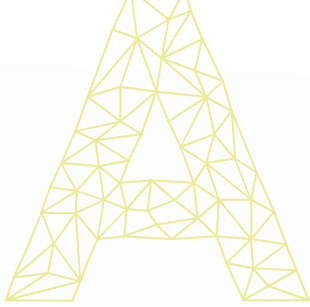

BRAVO

The range of rails for the BRAVA stretcher

Product certification

All KARTSANA products comply with the EN 1865 and 1789 standards.



07

Lateral movement

To optimise space in the ambulance and make work easier.



08

Backboard stretcher drawer

The R-1002C model can store a backboard or scoop stretcher.



09

CPR lock

Special lockable position for performing CPR inside the ambulance with greater comfort.



10

Telescopic

Easy to load.

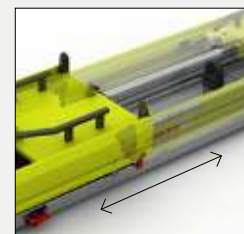

11

Integrated battery-charging system

Batteries charge automatically when inside the ambulance.



TG-1000 POWER BRAVA

- ▷ Control the stretcher from the operator's position.
- ▷ Adjustable headrest with shock absorber.
- ▷ Double-jointed leg rest with 2 shock absorbers.
- ▷ 4 ø160 mm rotating wheels. (2 remote-lockable wheels via pedal).
- ▷ Laterally and longitudinally collapsible guardrails.
- ▷ Three-point safety belt kit and IV pole.
- ▷ Aluminium tray for performing cardiac massages.
- ▷ The head area features a telescopic frame to facilitate manoeuvring in places with difficult access.
- ▷ Hydraulic system unlocking button in case of fault.



Neonates

Bariatric kit

The headrest area features a telescopic frame to improve manoeuvrability

DIMENSIONS AND WEIGHT

| | TG-1000 | |
|----|-----------------------------|------|
| H | Max. height (mm) | 1300 |
| HC | Max. adjustable height (mm) | 1030 |
| H2 | Min. height (mm) | 350 |
| L | Length (mm) | 1972 |
| L2 | Length closed (mm) | 1610 |
| L3 | Length open (mm) | 2100 |
| W | Width (mm) | 574 |
| | Load capacity (kg) | 300 |
| | Weight (kg) | 74 |

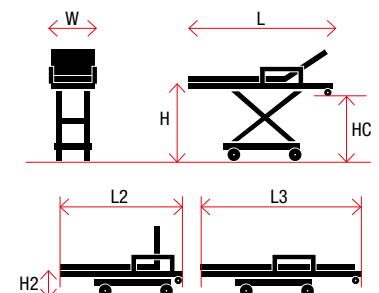

R-1002A BRAVO

- ▷ Telescopic BRAVO loading system with lateral movement.
- ▷ Certified 10G.

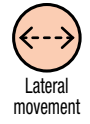

DIMENSIONS AND WEIGHT

| | R-1002A |
|--|---------|
| H Height (mm) | 360 |
| L Length closed (mm) | 2065 |
| L2 Length open (mm) | 3130 |
| W Width (mm) | 632 |
| A2 Height rail + stretcher (mm) | 535 |
| Weight (kg) | 103 |

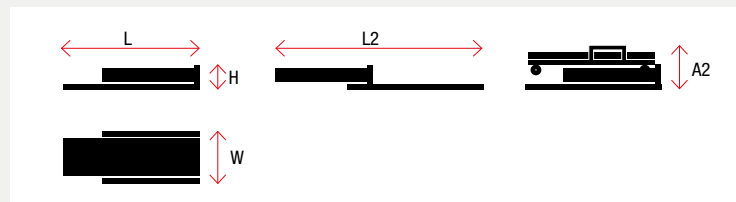

R-1001 BRAVO

- ▷ BRAVO loading system.
- ▷ Certified 10G.

AI
Aluminium
and stainless
steel

CERTIFIED
10G



R-1002C BRAVO

- ▷ BRAVO 2 loading system, with a drawer for storing a backboard stretcher.
- ▷ Certified 10G.

AI
Aluminium
and stainless
steel

Lateral
movement

Backboard
stretcher
drawer

CERTIFIED
10G



DIMENSIONS AND WEIGHT

| | R-1001 | R-1002C |
|--|--------|---------|
| H Height (mm) | 340 | 460 |
| L Length closed (mm) | 2050 | 2088 |
| L2 Length open (mm) | 3090 | 3145 |
| W Width (mm) | 590 | 632 |
| A2 Height rail + stretcher (mm) | 509 | 620 |
| Weight (kg) | 89 | 117 |

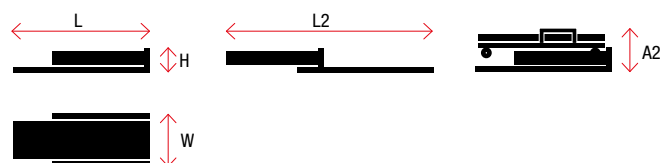



KARTSANA S.L.

Narcís Monturiol, 34
08192 · Sant Quirze del Vallès
Barcelona (Spain)
T.: +34 93 715 86 72
E.: info@kartsana.com
www.kartsana.com

07-2022

© 2022 · Kartsana. All rights reserved.